

Hydraulic Edge of Dock Submittal Drawing

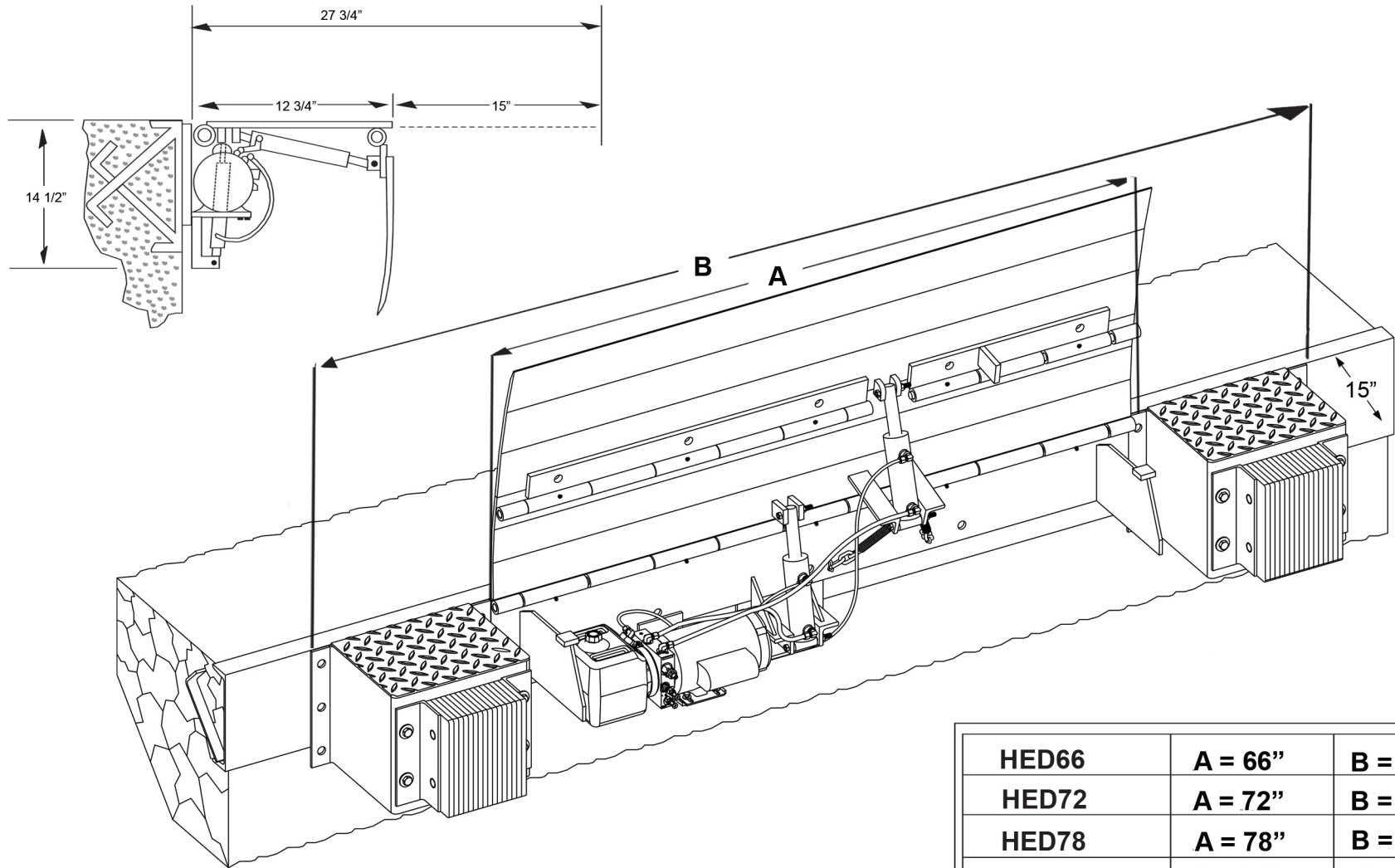

HED66	A = 66"	B = 104"
HED72	A = 72"	B = 110"
HED78	A = 78"	B = 116"
HED84	A = 84"	B = 122"
1/2 Hp. 1 ph. Std.	(3 ph. Opt.)	
25, and 30,000 lb capacities available		



PO Box 338 • Spring Hill, Tennessee 37174
 931.486.2296 • 800.251.3382 • Fax: 931.486.0316
www.pioneerleveler.com

JOB